

# Desert-Rib

Product Manual  
Installation Recommendations  
& Product Specifications

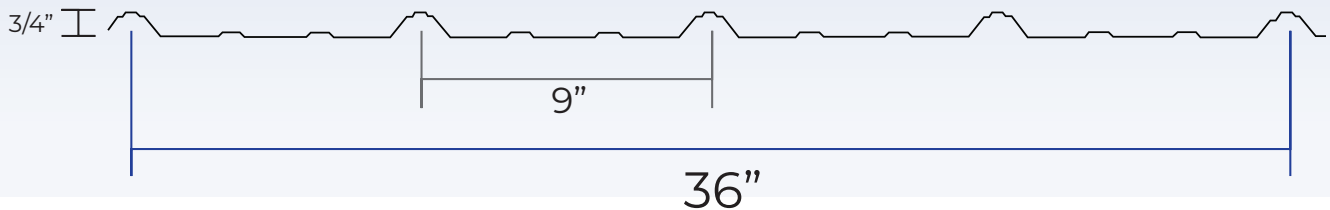
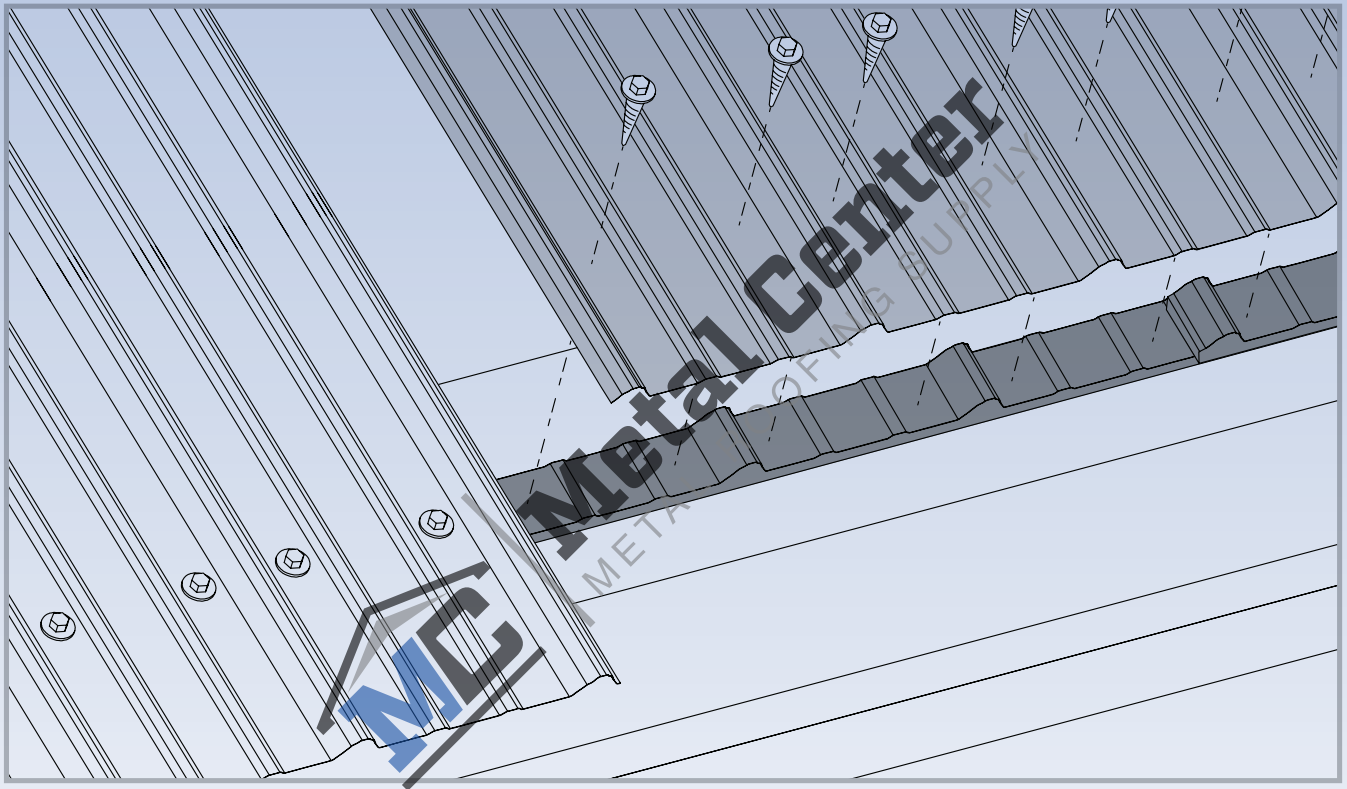

**Metal Center**  
METAL ROOFING SUPPLY

# Table of Contents

Product Manual Disclaimer	3
Safety Procedures	4
Tools & Equipment	5
Fastening Procedures	6
Roof Preparation	7
Installation Steps	8
Panel Installation	9-12
Eave Trim	13-15
Valley Trim	16-17
Rake Trim	18-19
Ridge Cap	20-21
Sidewall Trim	22-23
Endwall Flashing	24-25



**Metal Center**  
METAL ROOFING SUPPLY

## NOTICE:

This document includes helpful recommendations on ways to install the Desert-Rib panel profile. Always consult your general contractor on the installation methods that best suit your job, as every job is different.



**Metal Center**  
METAL ROOFING SUPPLY

# Disclaimer

This manual contains suggestions and guidelines on how to install Desert-Rib panels. The drawings in this guide are for illustration purposes only and may not apply to all building designs or product applications. The installation details shown are proven methods of construction, but are not intended to cover all instances, building requirements, designs, or codes. It is the responsibility of the designer/installer to ensure that the details meet particular building requirements. The designer/installer must be aware of, and allow for, expansion/contraction of roof panels. The details may require changes or revisions due to each project's conditions.

There are certain minimum live, snow, dead, collateral, and wind loads that a roof must generally be designed to support. Consult local building officials to determine the appropriate building design load requirements. A professional engineer should be consulted for all roof system

designs. It is the buyer's responsibility to verify all applicable code requirements, check all measurements, and determine suitability of product for the job. The buyer is also responsible for determining lengths and quantities needed. Prior to ordering and installing materials, all dimensions should be verified with field measurements. Implied warranties of merchantability and fitness for a particular purpose are disclaimed. All Desert-Rib instructions assume that a qualified individual has been contacted regarding application of this product. Failure to comply with stated recommendations relieves the manufacturer of responsibility for any damage or deterioration of the product incurred and voids any applicable warranty.

Metal Center, Inc. reserves the right to modify, without notice, information in this guide. If you have questions regarding proper installation of Desert-Rib or information not included in this guide, contact your salesperson.

## TOOLS & EQUIPMENT

- Gloves
- Safety Glasses
- Snips/Hand Shear
- Tape Measure
- Chalk Line
- Electric Metal Shear
- Cordless Drill
- Caulking Gun
- Hand Rivet Tool



# Safety Procedures

## SAFETY

Each jobsite presents different hazards; therefore it is the responsibility of the contractor to determine the safest way to install Desert-Rib based on the recommended instructions contained in this guide and provide crew members with appropriate safety measures. If you must walk on a metal roof, take great care. Metal panels can become slippery, so always wear shoes

with non-slip soles. Avoid working on metal roofs during wet conditions, when the panels can become extremely slippery. Walking or standing on a metal roof which does not have a plywood or other deck beneath it is not recommended. However, if you must do so, always walk on the purlins, never between.

OSHA safety regulations should be complied with at all times.

**Always wear heavy duty gloves when working with steel panels to avoid cuts from sharp edges. If power cutting or drilling steel panels, always wear safety glasses to prevent eye injury from metal debris.**



## RECEIVING MATERIALS

When unloading panels, extreme caution must be employed. Care needs to be used when unloading panels with a forklift. Panel edges and underside paint may become damaged if the forklift driver does not use caution.

## STORAGE

All materials should be stored in a dry place, preferably under a roof. Panels and trim are subject to staining and premature rusting when water sits upon, or becomes trapped between them. You may stand panels on end and fan them out at the bottom to provide air circulation and moisture run off. If space does not allow for this, the panels should be separated, blocked off the ground at least 12 inches to allow air flow and stored at an incline to encourage drainage. The panels should then be covered in a manner to still allow airflow through the sheets. Do not use a plastic cover, as this may cause the panels to sweat or condensation to occur.

Failure to properly store panels and trim could result in product failure that is not covered by manufacturers warranty.

## HANDLING

When unbundling the panels, never drag them across the surface of one another. This may cause scratches across the underneath panels. It is recommended that the panels be "rolled" off the top of the bundle to prevent scratching. Panels should only be lifted and carried by their sides. Panel edges are very sharp, therefore, safety equipment should be worn by all workers handling the material.

## FOOT TRAFFIC

When unbundling the panels, never drag them across the surface of one another. This can cause distortion of panel and damage to finish. Traffic over the installed roof must be kept to an absolute minimum.

If walking on the roof panels is unavoidable, walk only on the minor ribs to minimize damage.



# Tools & Equipment

## Common Tools Needed:

- Gloves
- Safety Glasses
- Tin Snips
- Tape Measure
- Chalk Line
- Electric Shear
- Cordless Drill
- Caulking Gun
- Hand Rivet Tool
- Circular Saw

### FIELD CUTTING

Metal Center recommends tin snips/hand shears, electric nibblers or a profile shear to cut metal panels and trim. All product surfaces should be free of debris at all times. Installed surfaces should be wiped clean at the end of each work period. Never cut panels over metal surfaces. When cutting metal panels, always wear heavy duty gloves to avoid cuts from sharp edges and safety glasses to prevent eye injury.

### DRILLING

Always use a cover sheet underneath your panel if you are predrilling fastener holes. Do not predrill more than one panel at a time. Predrilling multiple panels can cause shavings to become embedded in interior panels. Brush away any loose shavings immediately.



Shavings created by saw cutting or drilling may cause the panel to rust and could result in product failure that is not covered by warranty.

# Fastening Procedures

## Fasteners at Termination (Eave, Ridge, Valley, Endlap & High Eave)

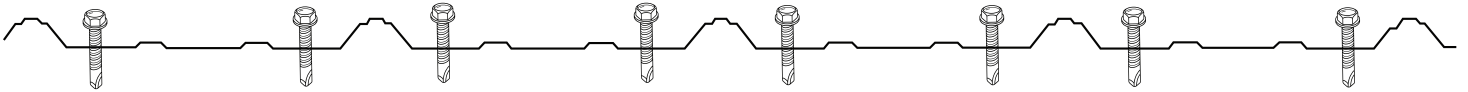

## Field Fasteners (3' - 5' Screw Spacing)

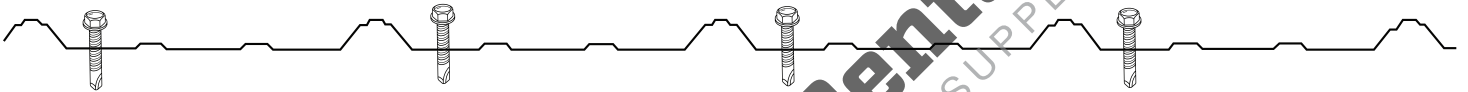

SECTION PROPERTIES								ALLOWABLE UNIFORM LOADS, psf For various fastener spacings											
Ga	Width in	Yield ksi	Weight psf	Top in Compression		Bottom in Compression		Inward Load				Outward Load							
				Ixx in <sup>4</sup> /ft	Sxx in <sup>3</sup> /ft	Ixx in <sup>4</sup> /ft	Sxx in <sup>3</sup> /ft	1.5'	2'	2.5'	3'	3.5'	4'	1.5'	2'	2.5'	3'	3.5'	4'
29	36	80	0.63	0.0097	0.0162	0.0060	0.0140	171	97	62	43	32	24	197	112	72	50	37	25
26	36	80	0.80	0.0123	0.0207	0.0080	0.0181	221	125	81	56	41	32	251	143	92	64	47	32
24	36	50	1.05	0.0163	0.0268	0.0117	0.0241	245	139	90	62	46	35	271	154	99	69	51	39

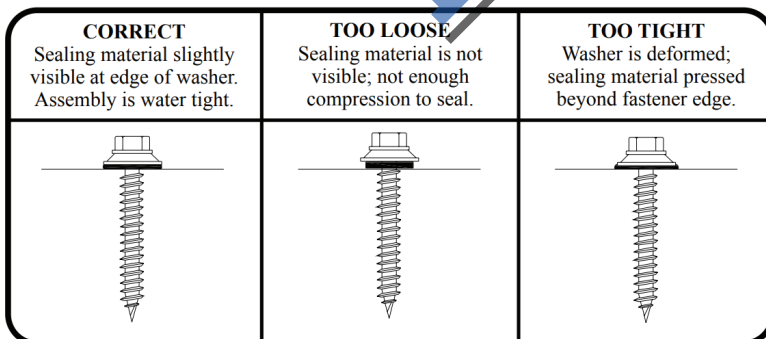

## Fastener Spacing

Field Screws: 3' to 5'

Lap Screws: 3' to 5'

# Roof Preperation

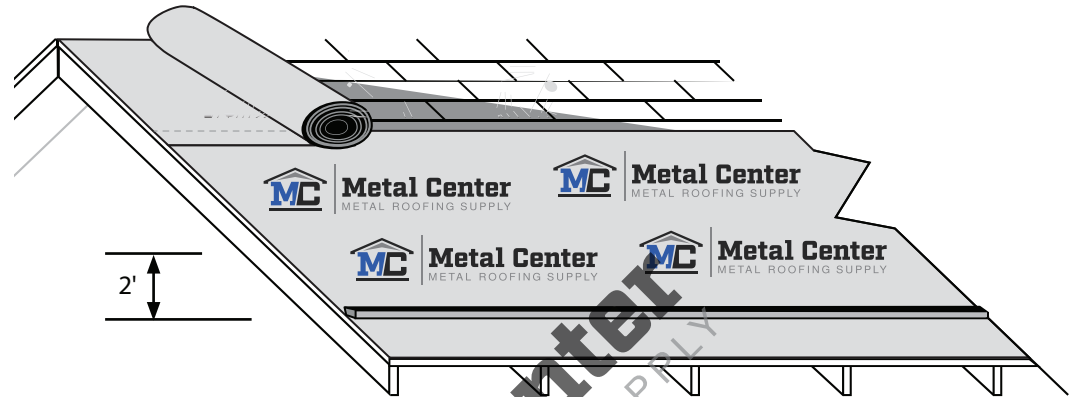

## EXISTING SHINGLES

1. Make sure any existing decking is smooth, level and in good condition. Remove any damaged shingles or debris that might interfere with installation.
2. Apply synthetic underlayment using staples. Plastic cap nails are not recommended.
4. Check for roof squareness. Follow guidelines on page 10.
5. Begin installation of trim and panels following guidelines on pages 12-13.



Check local codes when overlaying metal roofing on existing shingles. It is not recommended to install over more than 2 layers of shingles. Shingles may rot between layers due to trapped moisture, or substructure may fail due to weight of shingles and metal roof.

# Installation Steps

Installation order will vary from roof to roof. Recommended installation of Desert-Rib is shown below.

The contractor will determine which conditions apply.

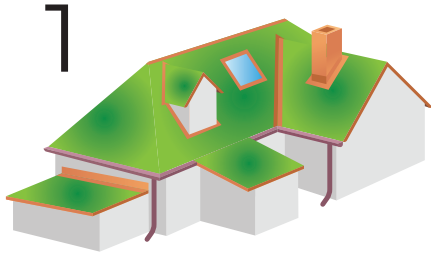

1 UNDERLAYMENT

NOTE: Install any additional ice and water shield in valleys if appropriate at this time.

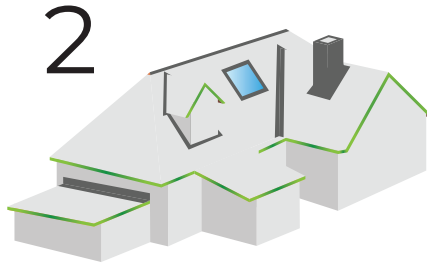

2 FASCIA TRIM

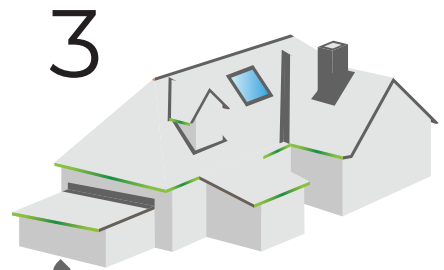

3 EAVE TRIM

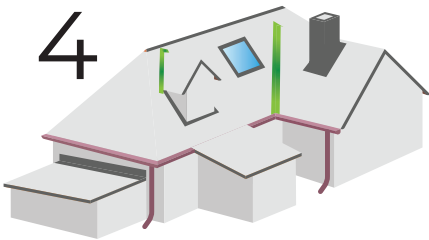

4 VALLEY TRIM

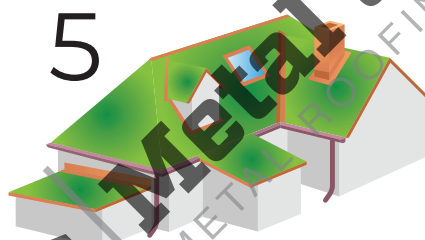

5 PANELS

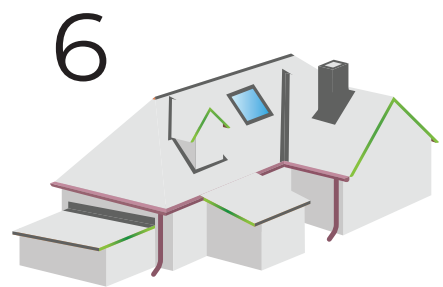

6 RAKE TRIM

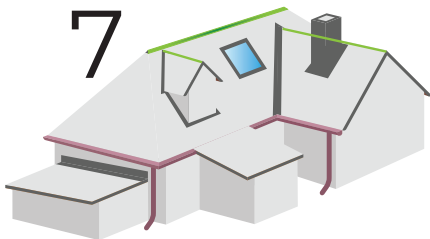

7 RIDGECAP

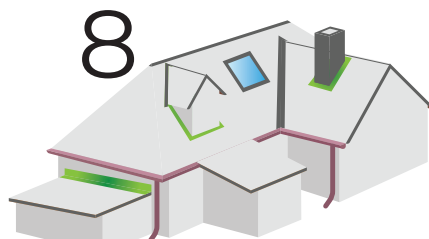

8 ENDWALL & SIDEWALL

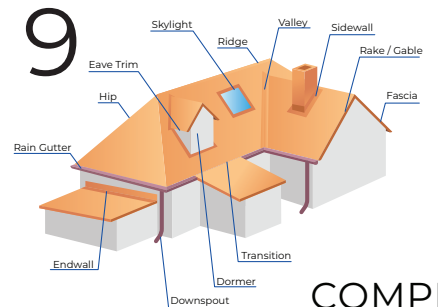

9 COMPLETE



# Panel Installation

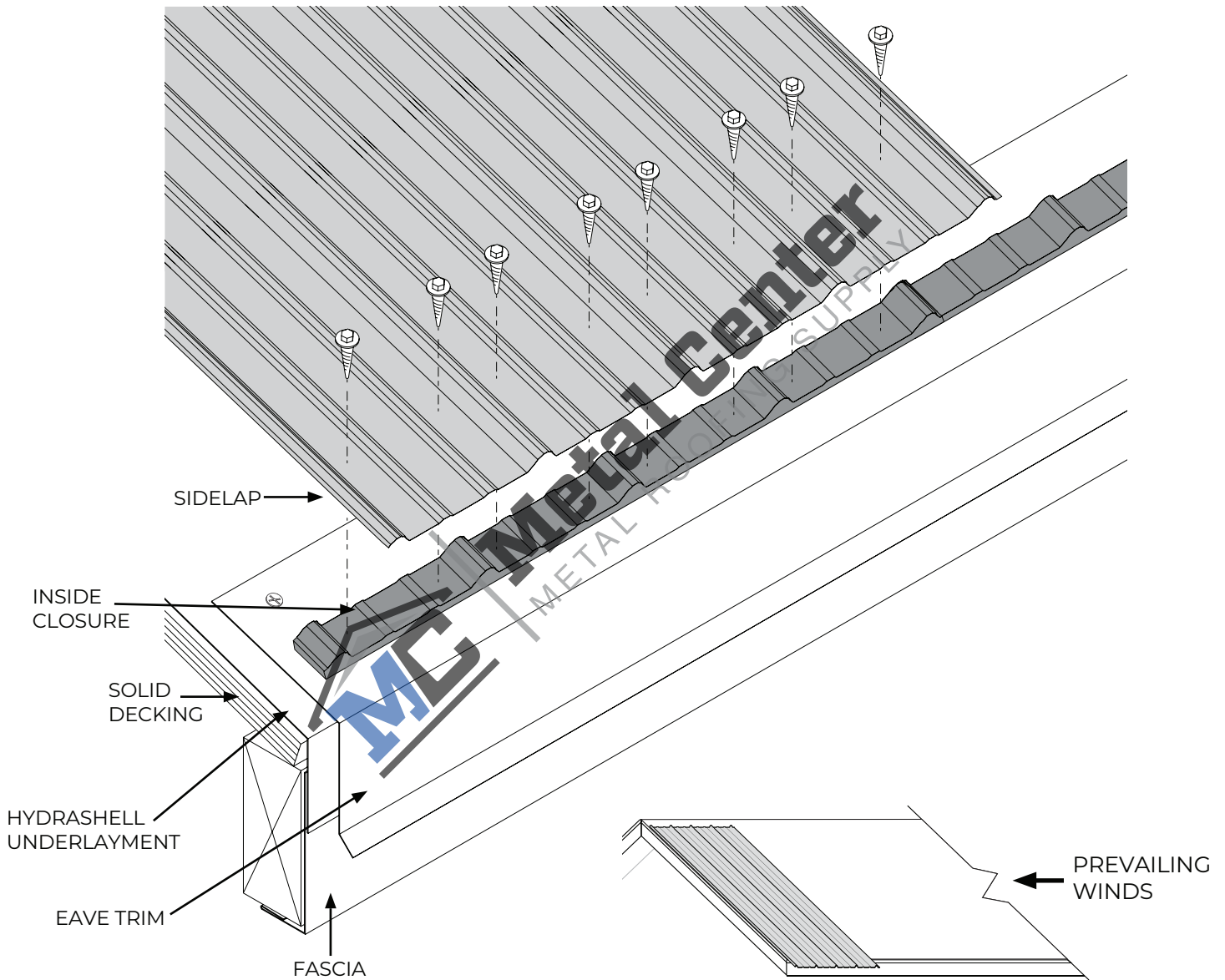

Copper metallic panels must be installed in the same direction!



# Panel Installation

1. The panel should overhang from the eave a desired amount. If installing gutters, a 1" overhang is suggested. An overhang of 6" or more may not support weight of snow or debris.
2. Fasten at the eave according to the fastener pattern below. The fasteners should penetrate through the inside closure, through the eave trim and into the substrate below.
3. Continue by fastening the panel every 3-5' running towards the ridge. Use the interior panel fastener pattern.
4. Continue with panel run using sidelaps.

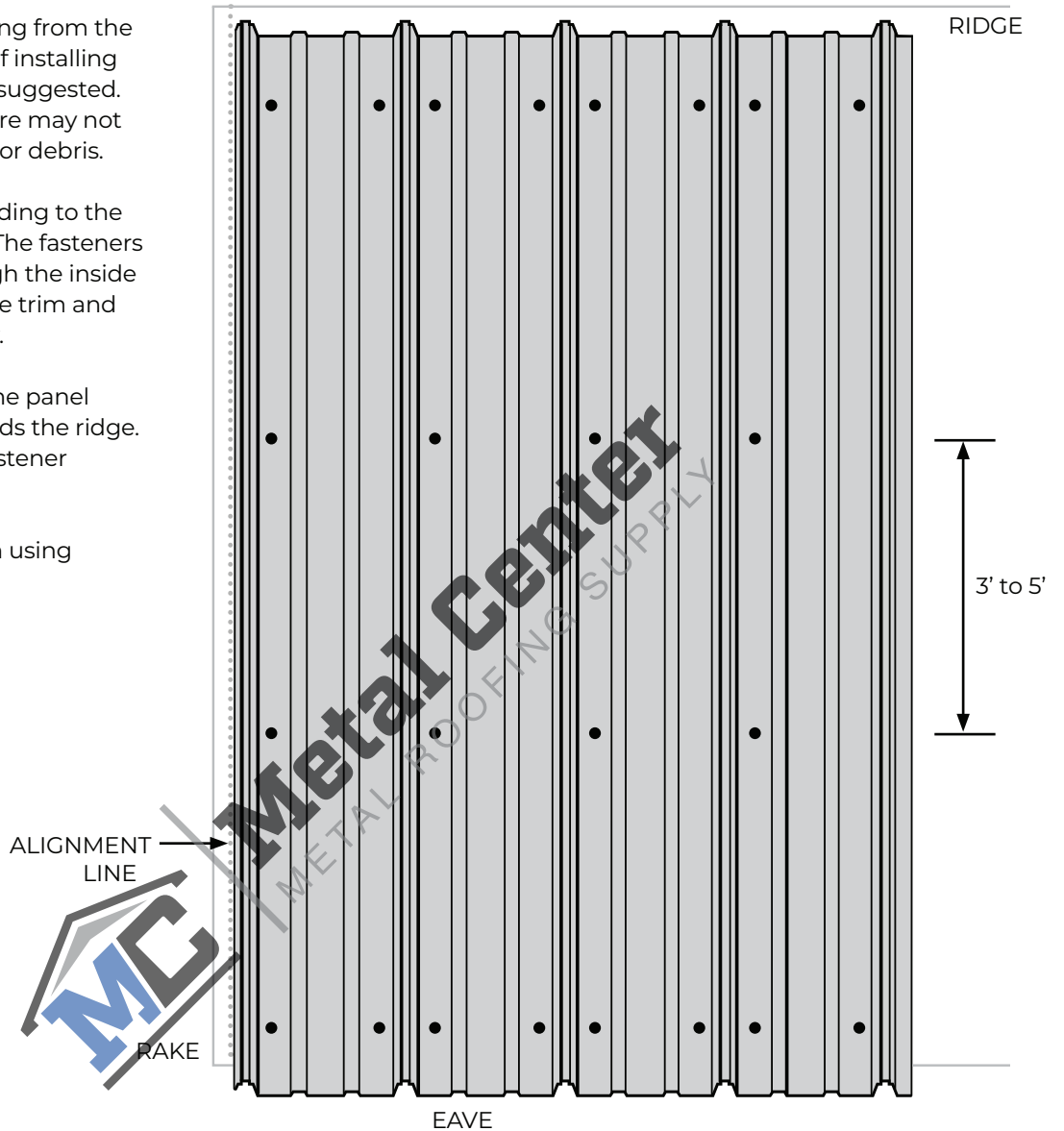

**Fasteners at Termination**  
(Eave, Ridge, Valley, Endlap & High Eave)

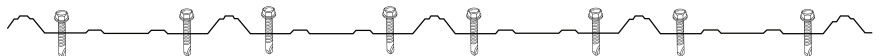

**Field Fasteners**  
(3' - 5' Screw Spacing)

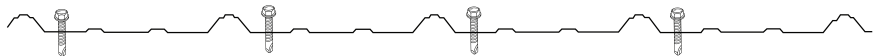

# Panel Sidelap

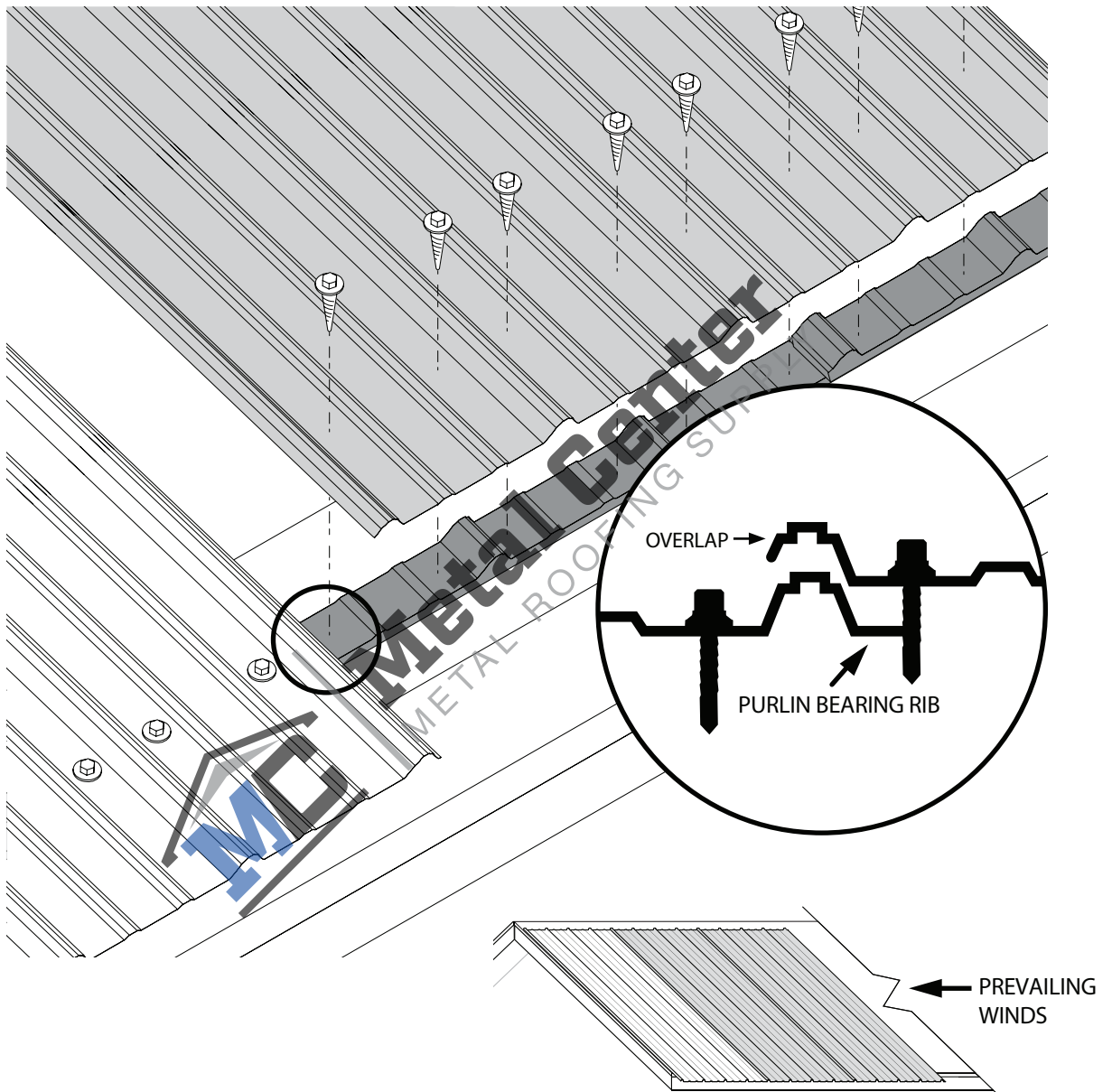

# Panel Endlap

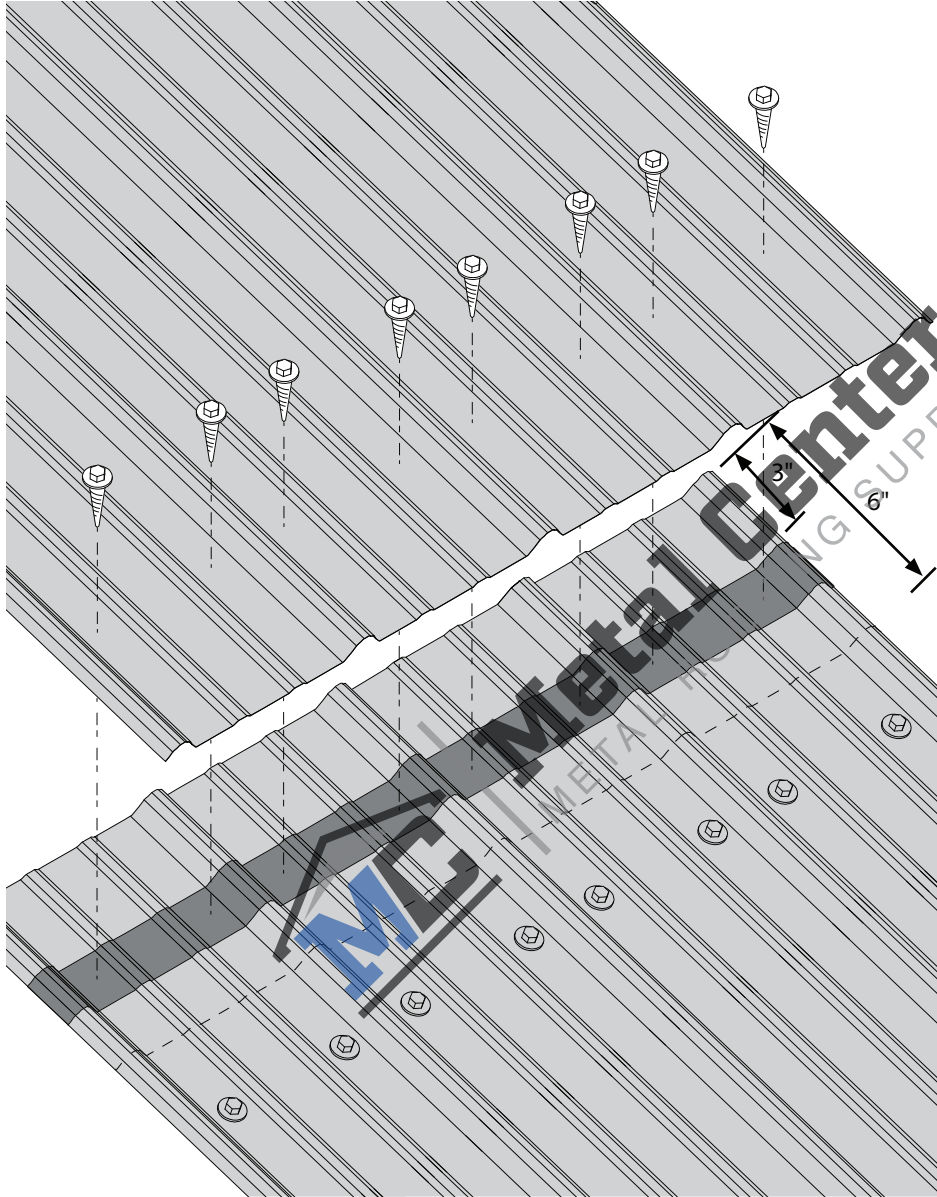

1. Starting at 3" from the end of the panel to be lapped, apply a line of butyl tape over the ribs.
2. Overlap the next panel 6".
3. Fasten the two panels together through the butyl tape and into the substrate below. This should be about 3" back from the overlapping panel.
4. Continue by fastening the panel every 3-5' running towards the ridge. Use the interior panel fastener pattern.

# Eave Trim

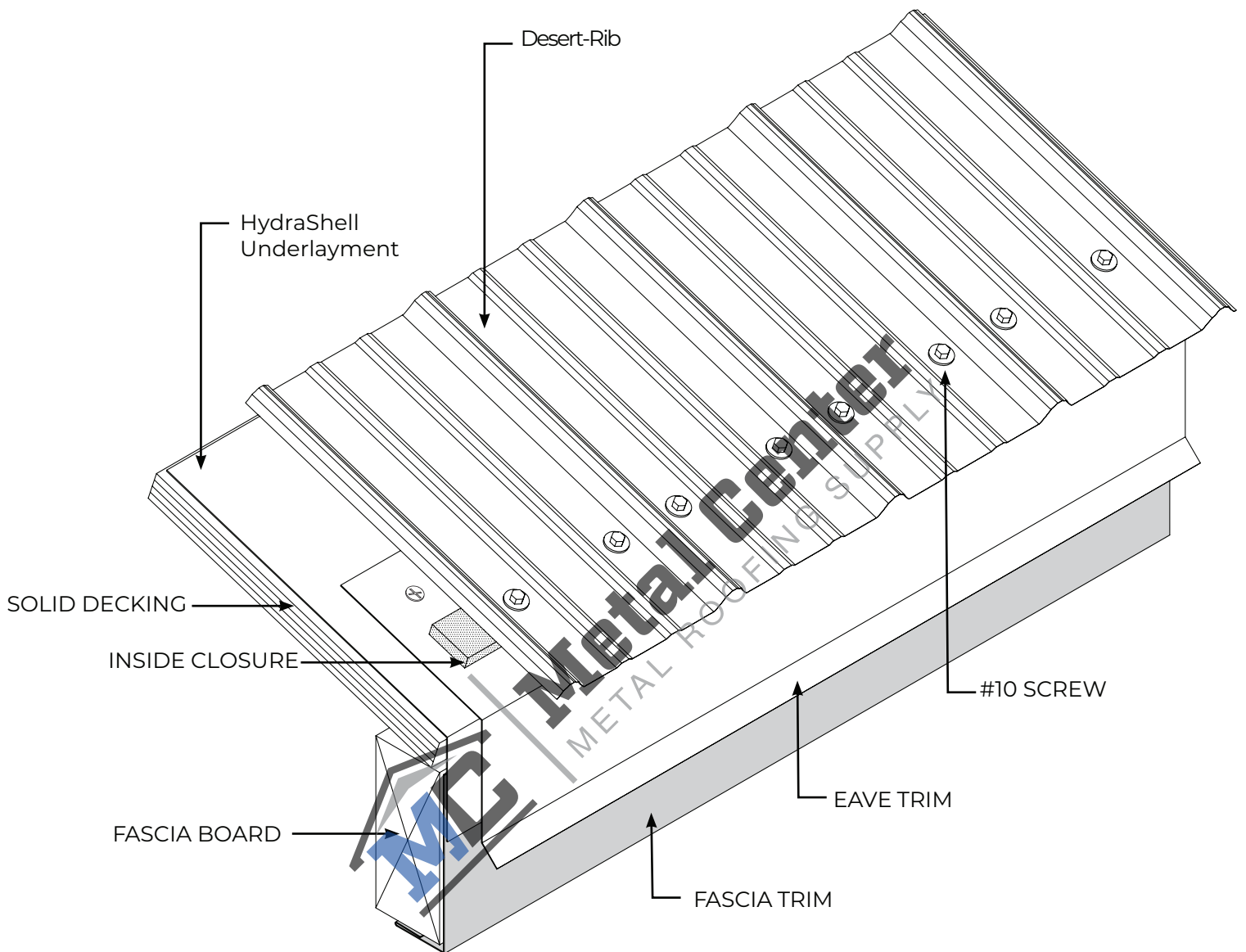

# Eave Trim

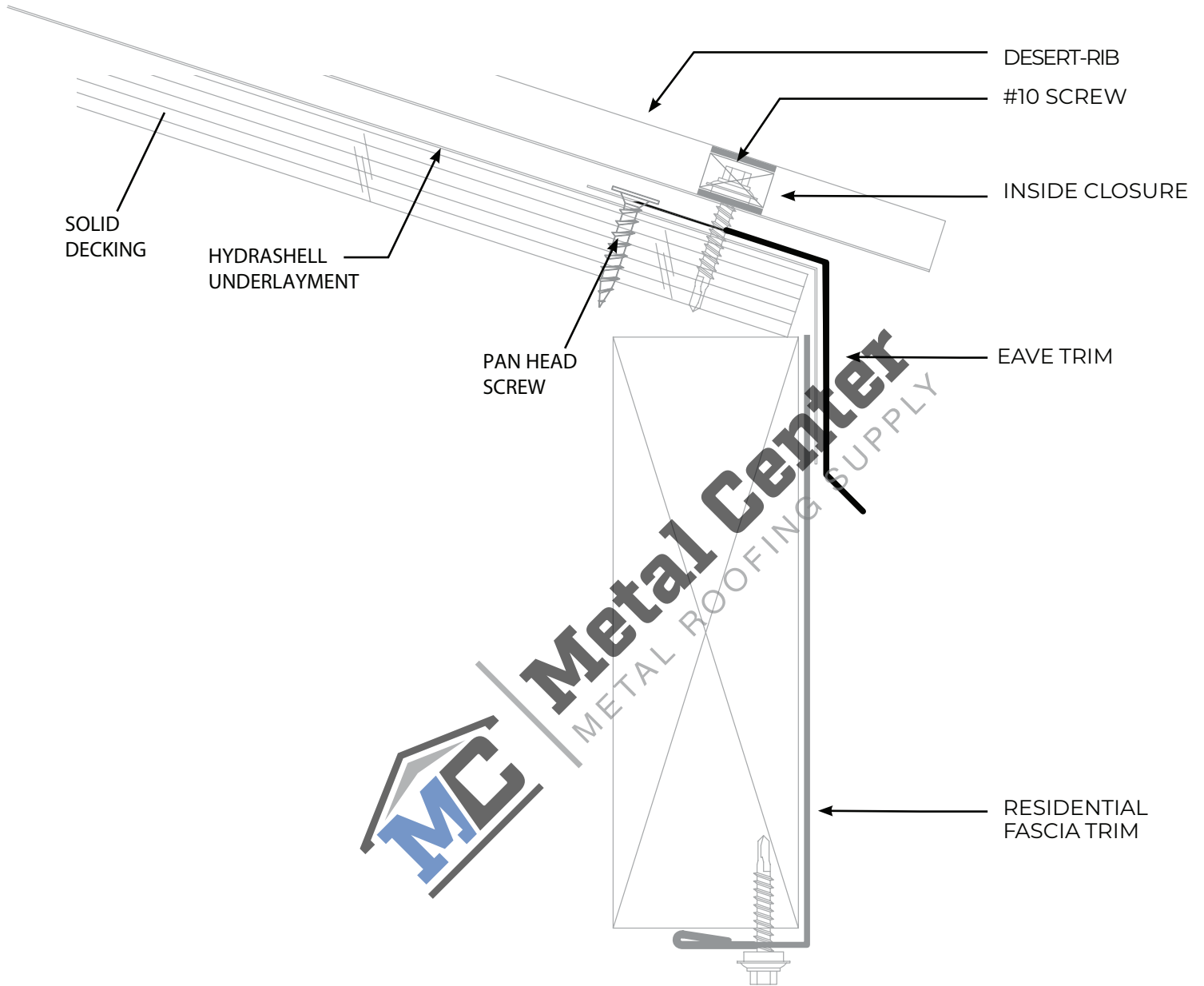

# Eave Trim

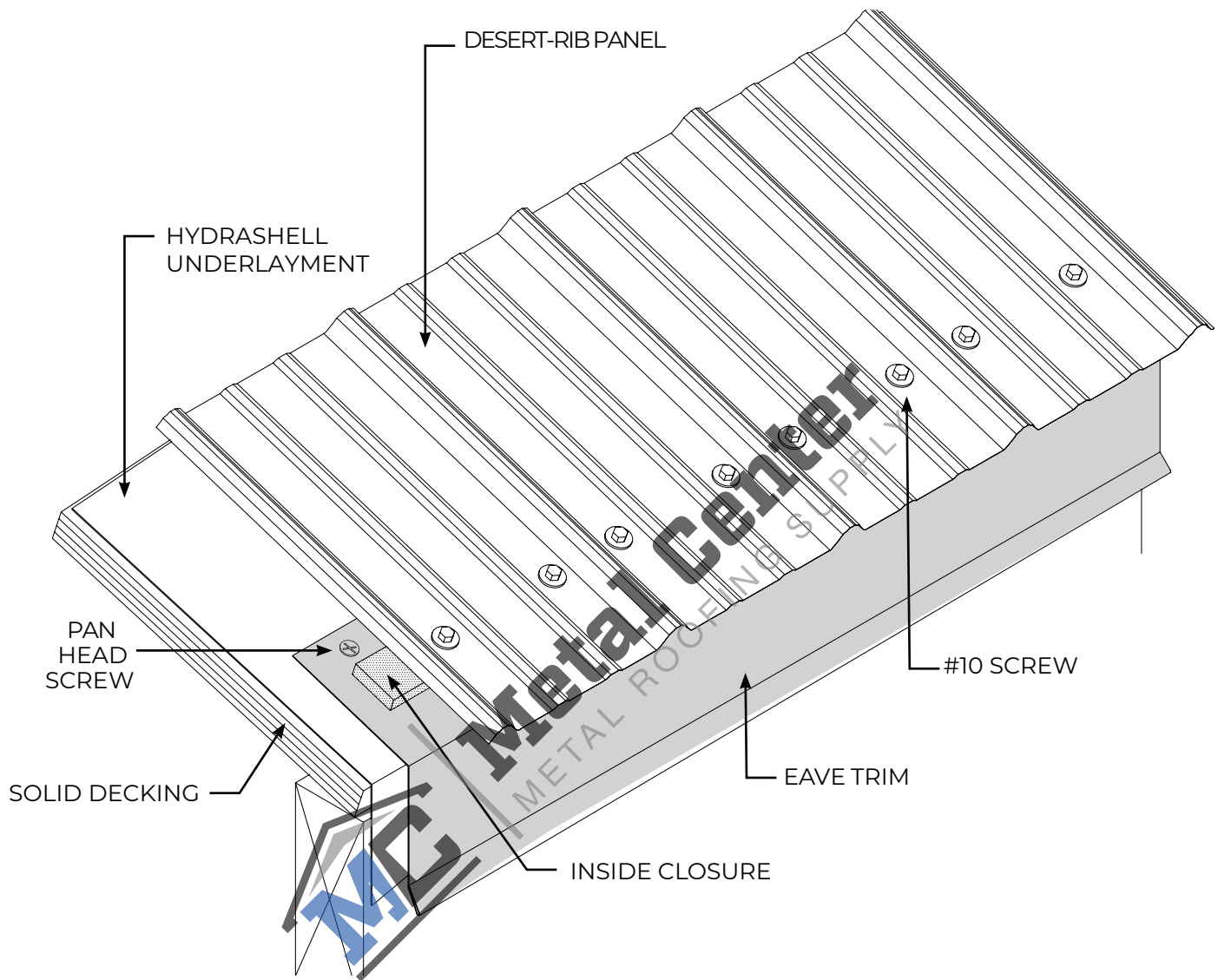

## DIRECTIONS:

1. Fasten eave trim to the roof deck as shown with appropriate fastener. Fastener spacing is not important because the panel will fasten through the trim in a later step. Pan head screws are recommended for this portion of application. If you are using a hex-head screw, fasteners should be placed appropriately to be hidden under the panel rib. Fasteners should be placed no more than .75" from the top of trim to allow for closure placement in later step.
2. Install inside closure with adhesive on top of installed eave trim. Later, the screws fastening the panel will run through the inside closure.
3. Place panel on roof, aligning with inside closure. The edge of the panel should be placed at the desired overhang of the fascia.
4. Fasten panel according to fastener pattern, fastening through the closure, into the roof.

# Valley

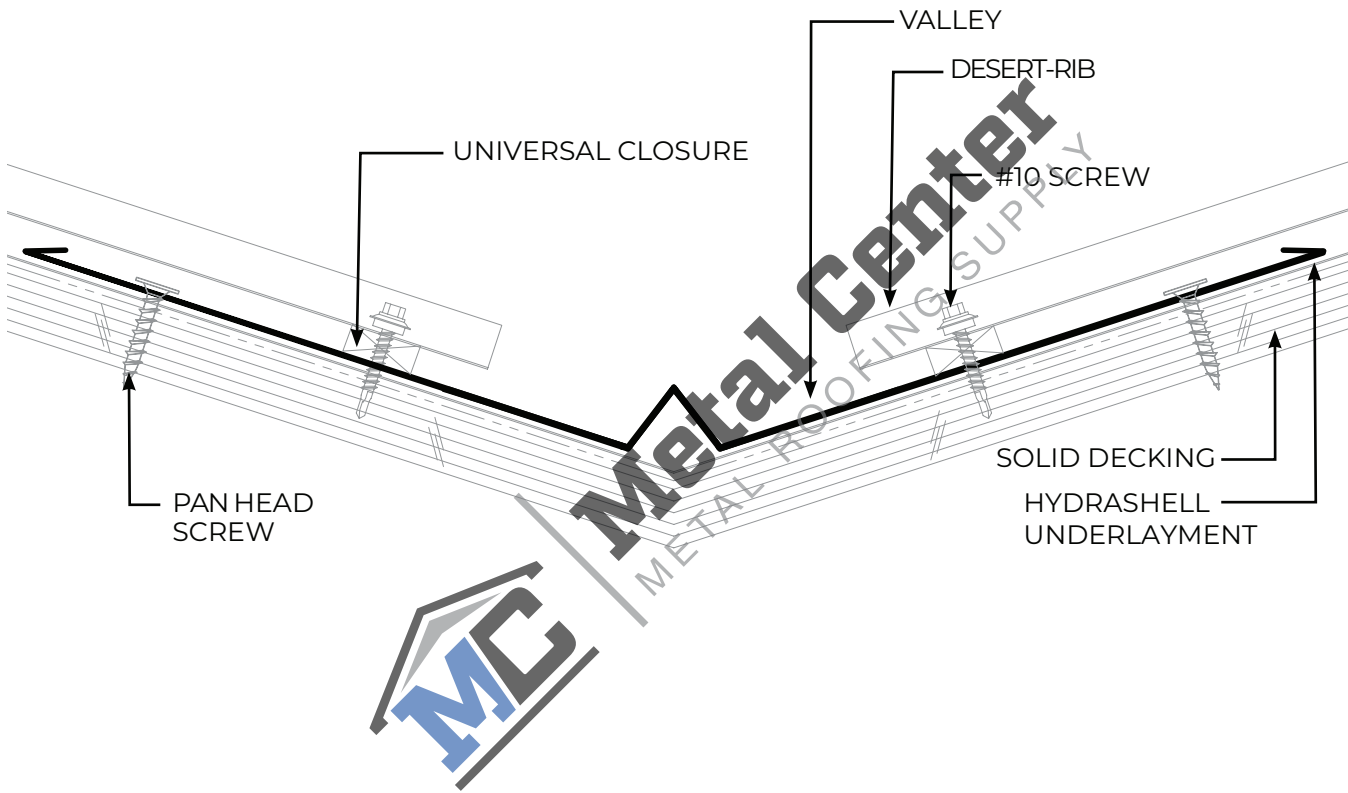



# Valley

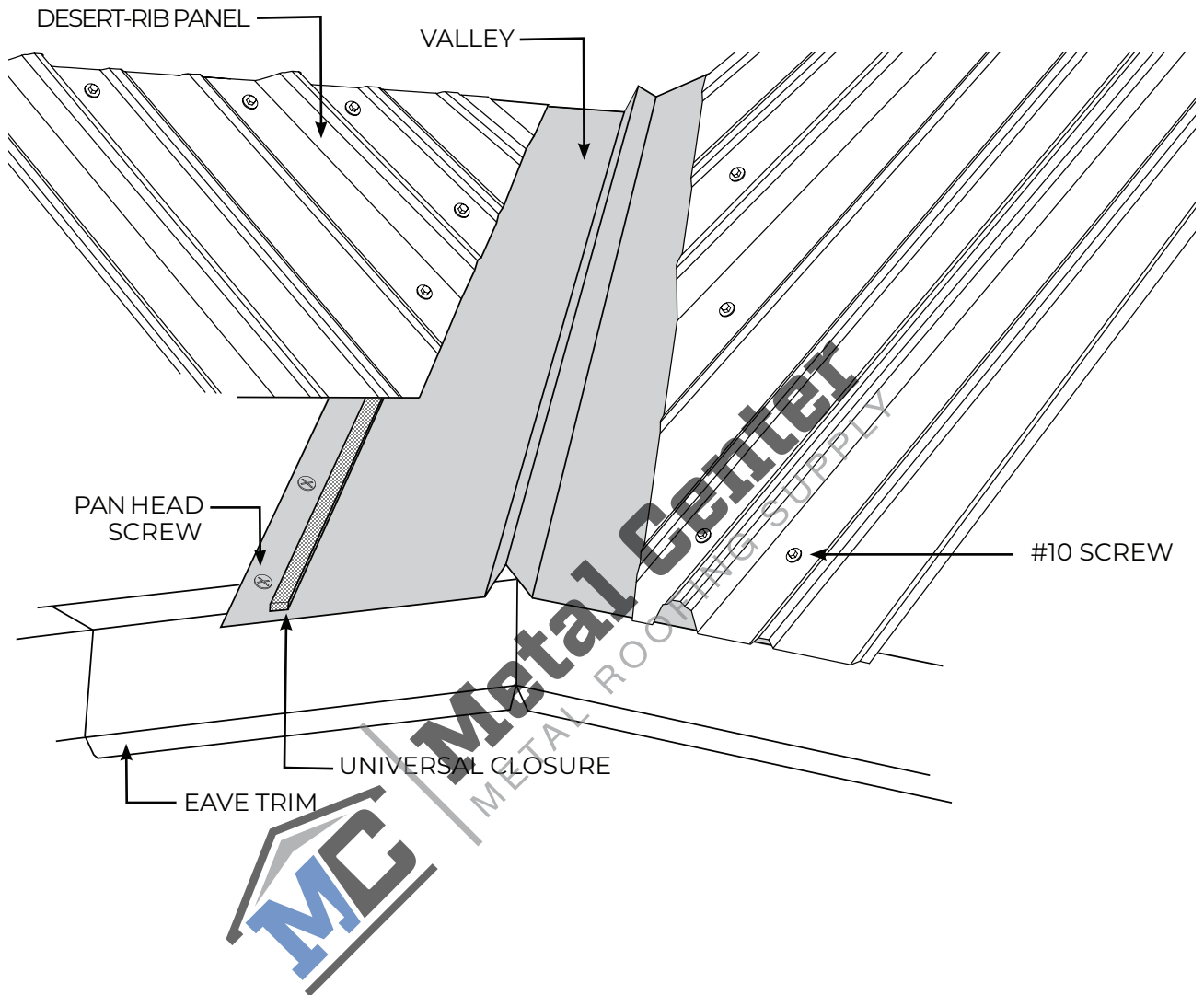

## DIRECTIONS:

1. Place the valley trim on the roof so that both sides sit flat on roof decking.
2. Prior to fastening, the lower end must be cut to line up with the edge of the roof sections.
3. In most cases the top end will meet another valley coming from the other side of the roof section. The upper ends of each piece will need to be trimmed so that they can be overlapped.
4. The valley should be fastened to the roof deck no more than 2" from the outer edges. Place enough fasteners to secure it until roof panel is applied. Wafer head screws are recommended for this portion of application. If you are using a hex-head screw, fasteners should be placed appropriately to be hidden under the panel rib.
5. Universal closures are used as primary closures in valley applications.
6. When installing panels in a valley, the lower end of the panels should stop 3-4 inches from the center of the valley. Use endlap fastener pattern.

# RAKE TRIM

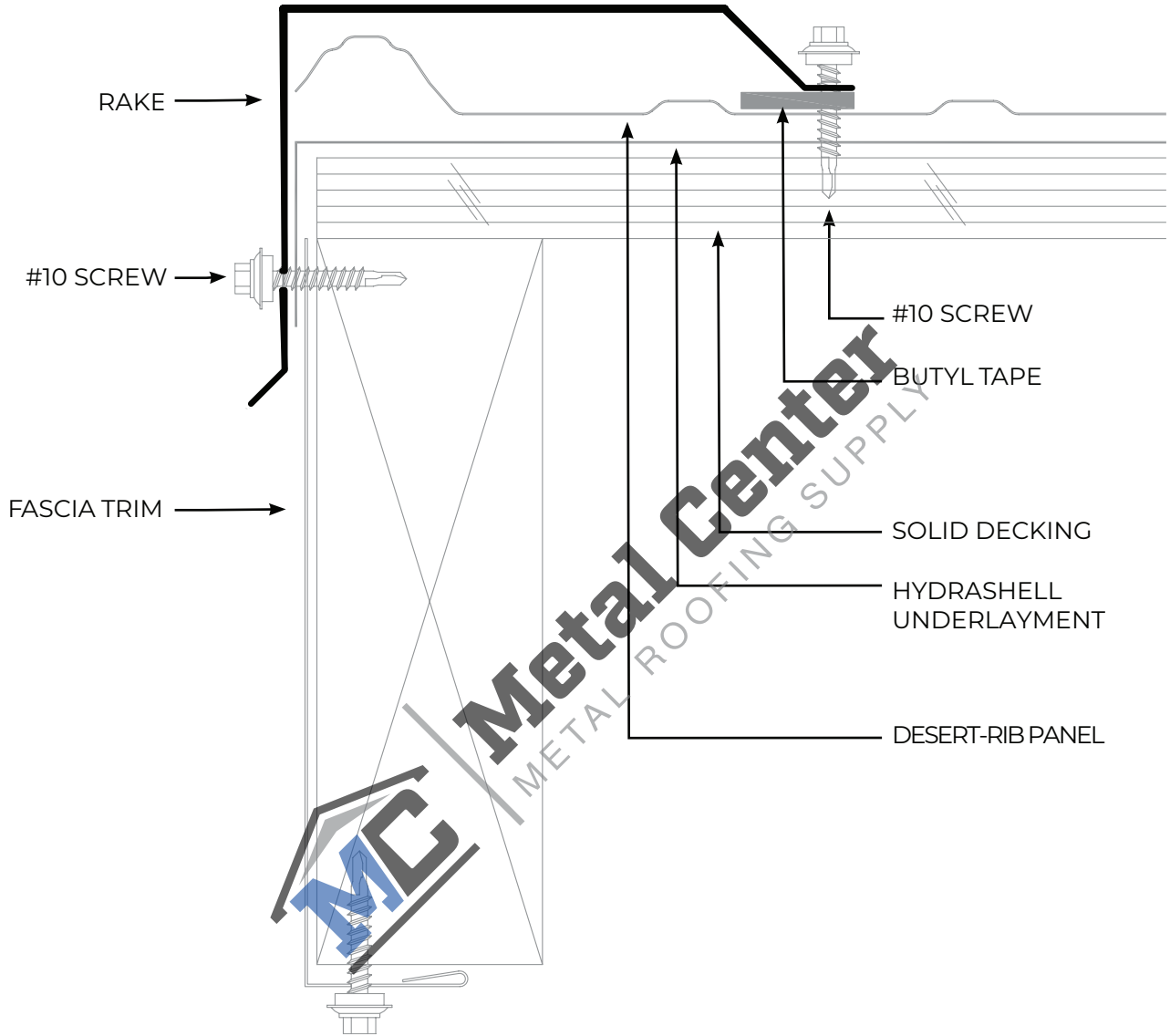

# RAKE TRIM

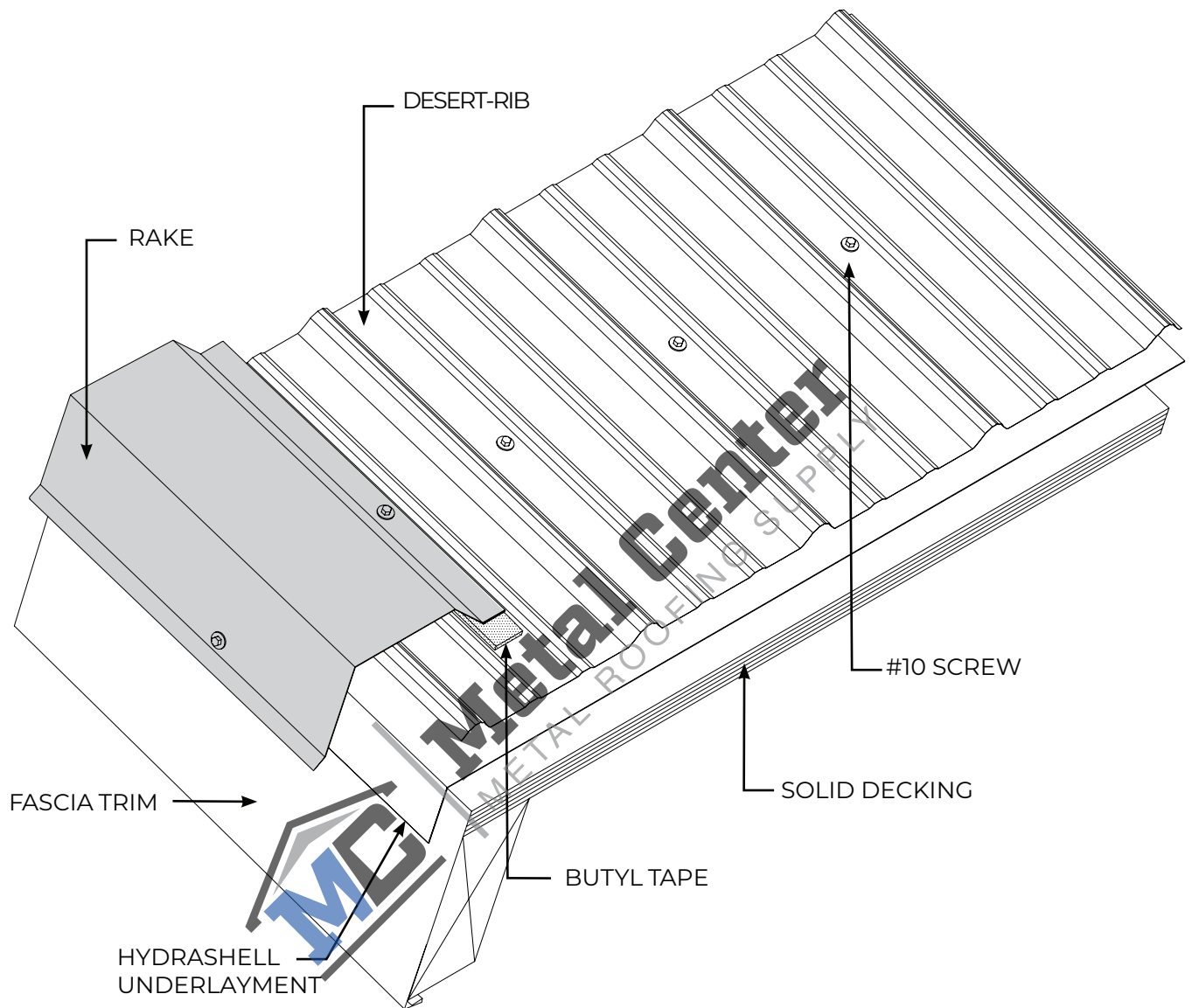

## DIRECTIONS:

1. Install panel aligned with edge of roof.
2. Apply butyl tape to the leg of the rake that will be fastened to the roof (the non flat side) extra width of butyl tape should be hidden inside the trim, rather than exposed to the weather. To apply, unroll butyl tape and stick to the trim. Leave backer on butyl tape until just prior to installation.
3. When ready to install the piece, peel the backer off of the butyl tape and align rake trim so that the face (flat side) of the rake is against the fascia and the top of the rake is at the same height as the panel rib.
4. Install fastener through the rake and butyl tape into the roof. Install another fastener into the face of the rake and the fascia about an inch above the rake. Fasten the length of the trim following the fastener pattern established at panel installation.



# RIDGE CAP

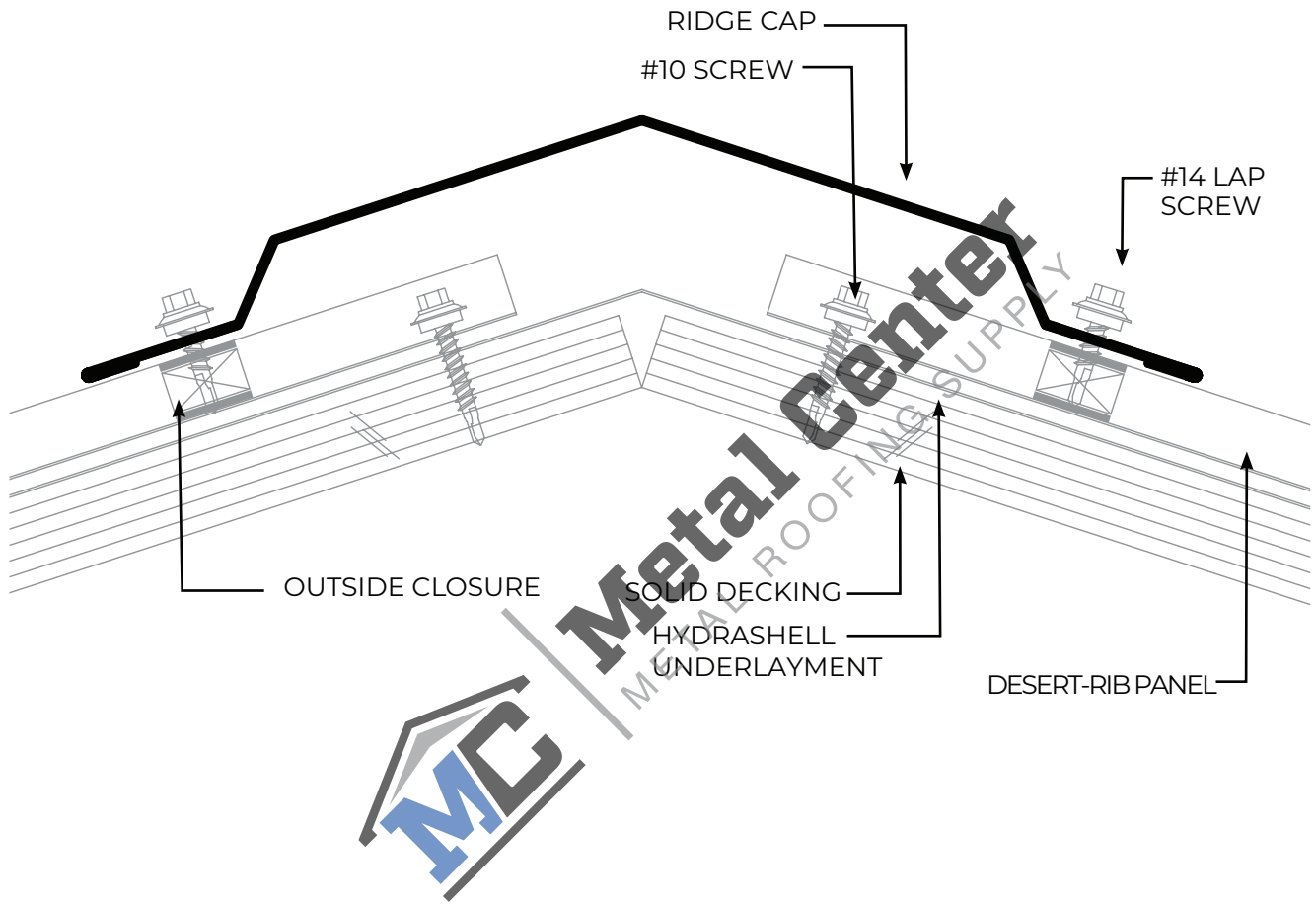

# RIDGE CAP

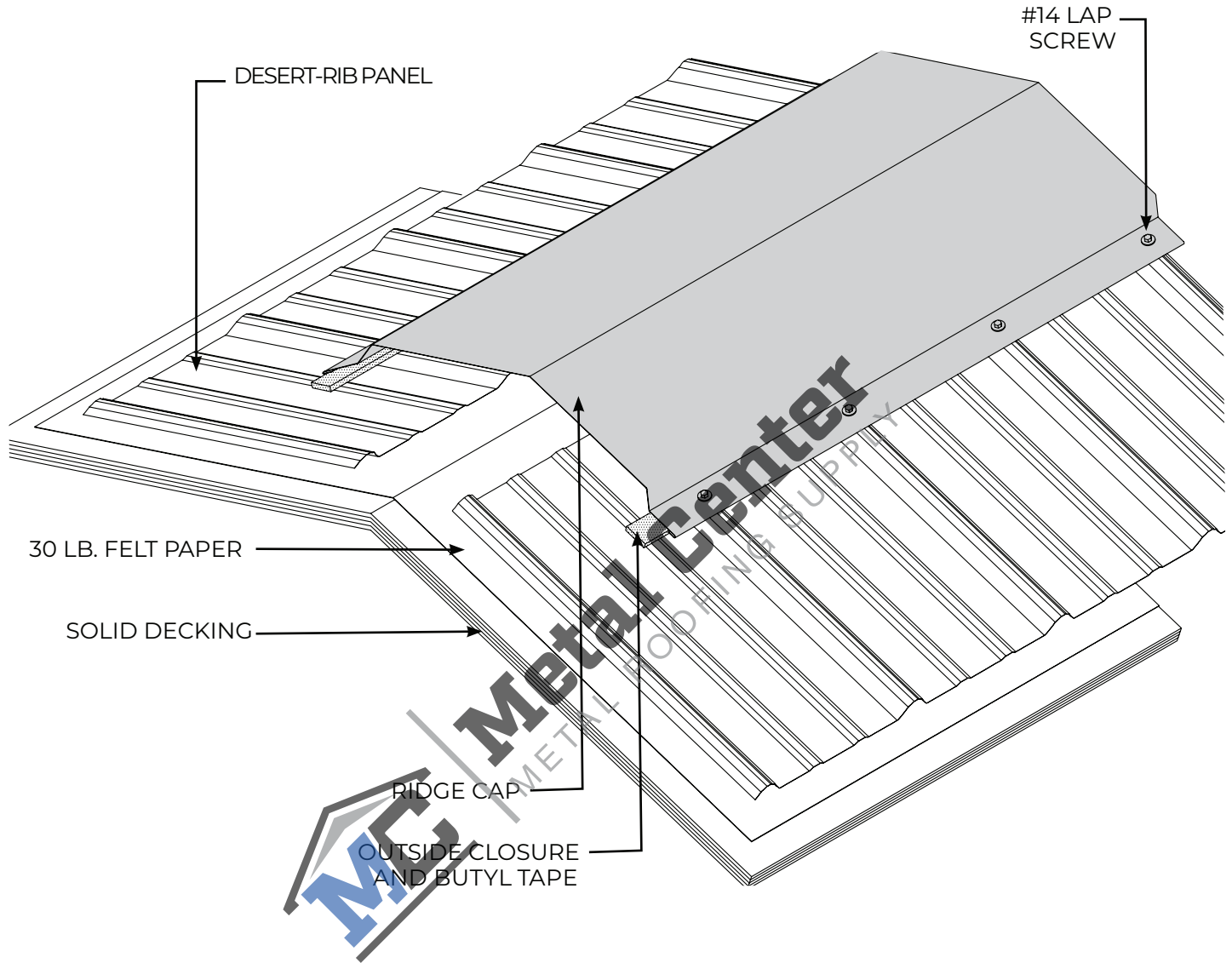

## DIRECTIONS:

1. Before installing the ridge, the roof panels should be properly installed up to the peak of the roof. There should be a closure under the upper edge of each side of roof panels.
2. Before placing the ridge, place butyl tape on each side of roof panel where you will install outside closures so that when fasteners are used to secure the ridge, they will go through the closure into the rib of the panel. Install outside closure and place another run of butyl tape on top of the outside closure.
3. Place the ridge make sure the center of the ridge cap is in line with the peak of the roof.
4. Fasten the ridge to the panel at each rib down the entire length of the ridge. Lap screws are recommended for this portion of application. Remember the fasteners should go through the line of closure.



# SIDEWALL

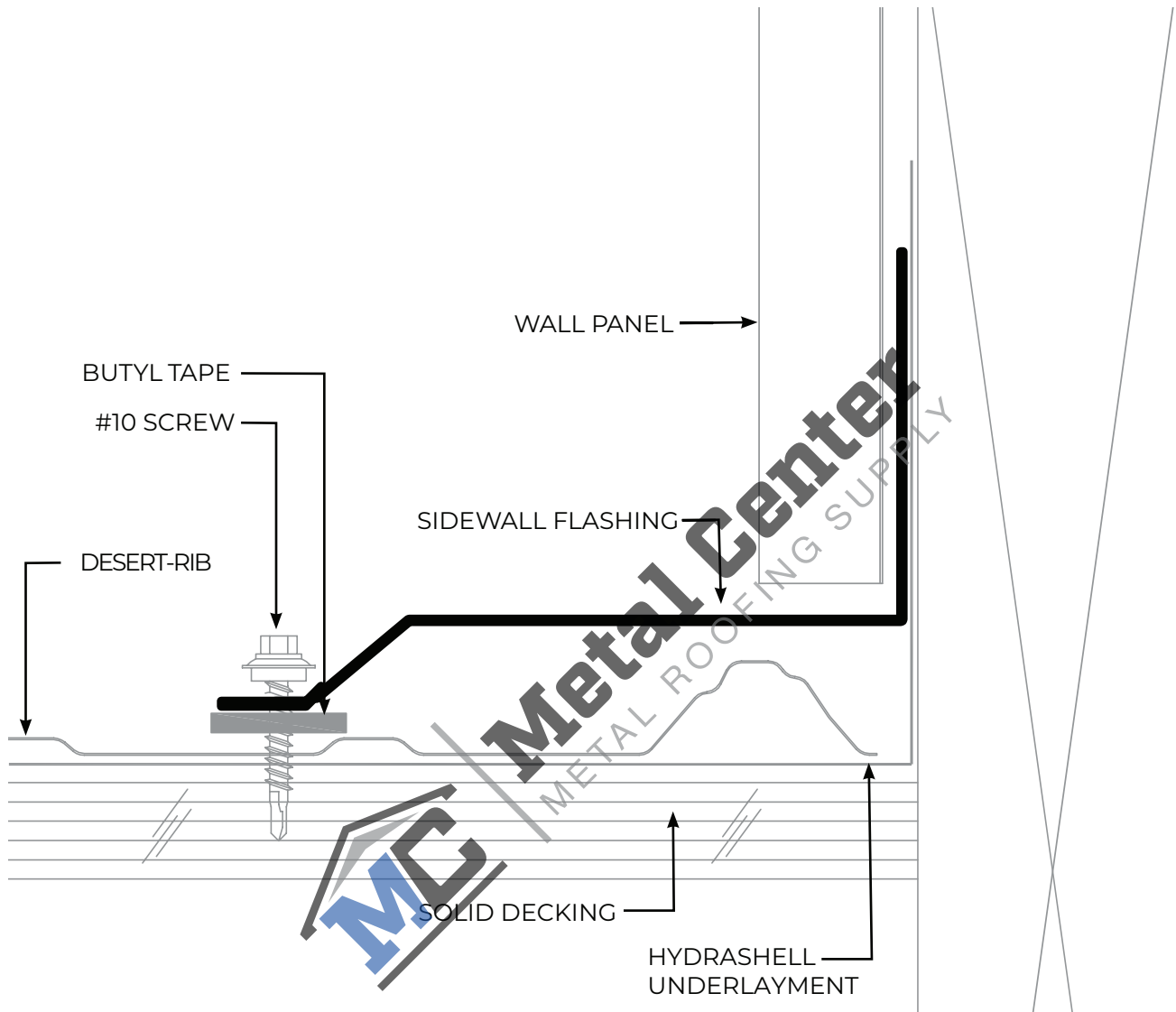

# SIDEWALL

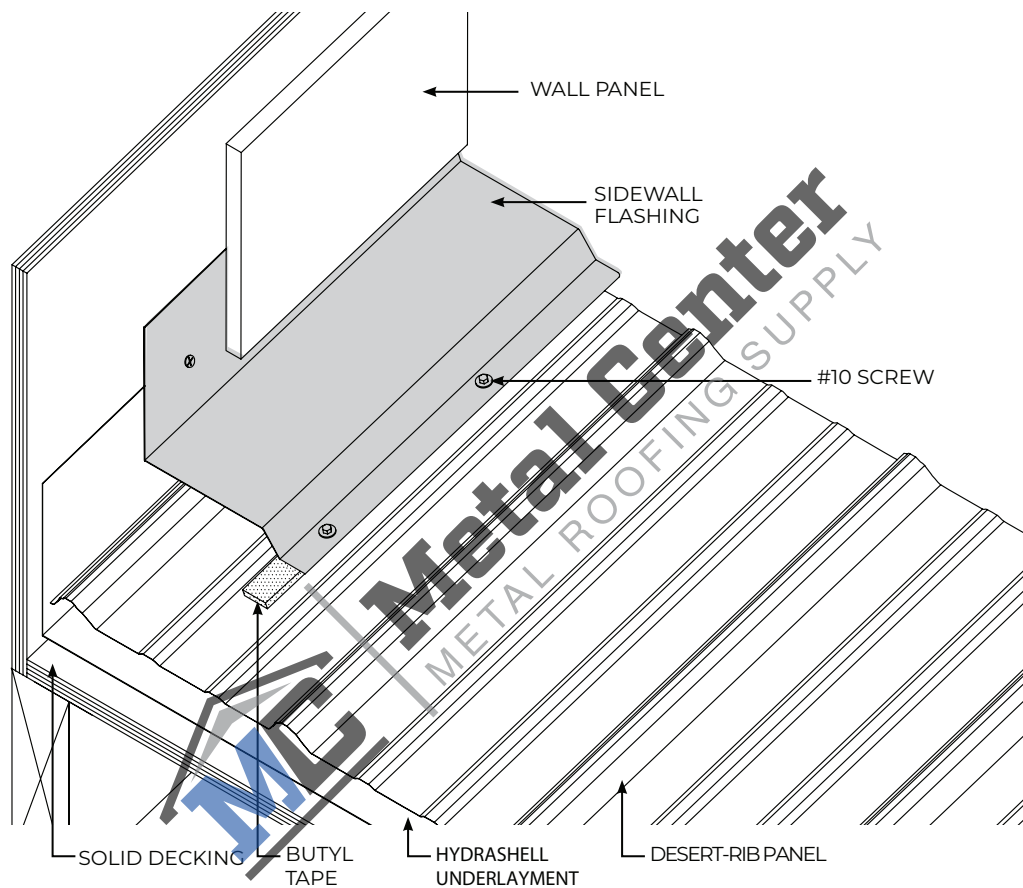

## DIRECTIONS:

1. Roof panels must be installed prior to the installation of sidewall.
2. Butyl tape should be placed along the entire length of the leg of the trim piece.
3. Place the sidewall so that the vertical leg is flat against the wall. It is recommended that this go behind outer wall coverings like siding if possible. Fasten if necessary. To avoid creating an area where
4. rust could occur make sure cut edge of the wall panel is at least 1/4" away from sidewall flashing.
4. Fasten through the butyl tape, into the roof decking along the length of trim, following the fastener pattern established at panel installation.



# ENDWALL

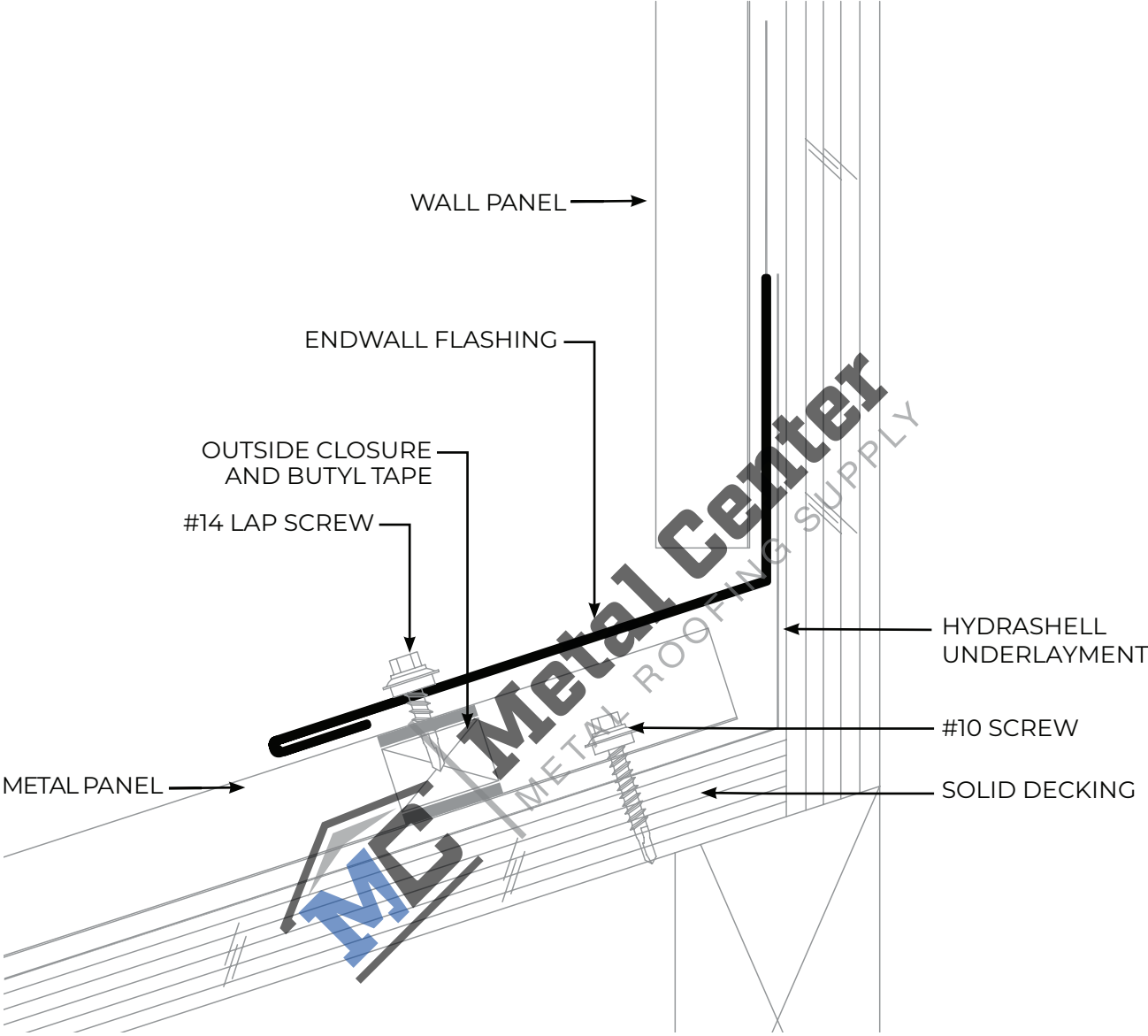



# ENDWALL

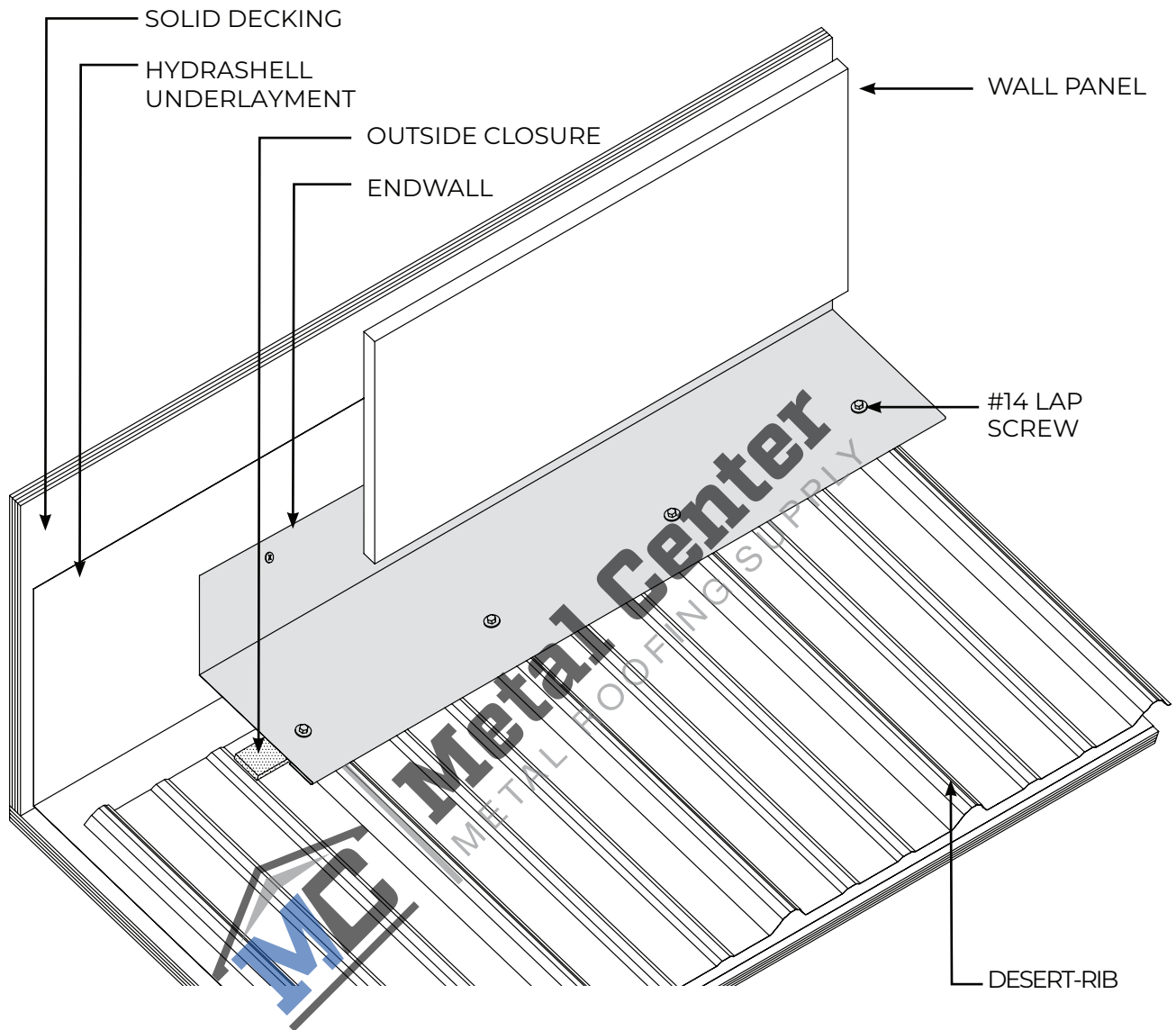

Always overlap Endwall Flashing trims the length of two ribs to reduce a wavy appearance.

## DIRECTIONS:

1. Roof panels must be installed prior to the installation of EFF.
2. Place a run of butyl tape along the entire length of the hemmed leg of the trim piece. Install outside closure.
3. Place the EFF so that the vertical, unhemmed leg is flat against the wall. It is recommended that this go behind outer wall coverings like siding if possible. To avoid creating an area where rust could occur make sure cut edge of the wall panel is at least 1/4" away from the endwall flashing.
4. Fasten the endwall trim into the roof decking along the length of trim, at each rib in the roof panel. Lap screws are recommended for this portion of the application.

